



# TWO-WHEEL TRACTORS

AND ATTACHMENTS

language



**FERRARI**

A COMPLETE RANGE OF PROFESSIONAL AND MULTIFUNCTIONAL TWO-WHEEL TRACTORS THAT ALLOW ALL THE FOLLOWING NEEDS TO BE FULFILLED, IN EVERY SEASON OF THE YEAR:

- SOIL PREPARATION FOR SOWING
- CARE OF GARDENS
- GREENS MAINTENANCE
- INTER-ROW MOWING OF VINEYARDS AND ORCHARDS
- CLEARING OF UNCULTIVATED AREAS
- CLEANING OF DRIVEWAYS OR BARNs
- SNOW REMOVAL

THANKS TO THE FERRARI TWO-WHEEL TRACTORS BEING SO SIMPLE TO HANDLE AND USE, THEY CAN BE USED BY A VAST RANGE OF USERS: FROM HOBBY FARMERS TO PROFESSIONAL FARMERS, AND FROM INDIVIDUALS TO THE GREENERY CARETAKER.

THE EXCLUSIVE POWERSAFE® HYDRAULIC CLUTCH ALSO GUARANTEES MAXIMUM RELIABILITY, COMFORT AND TOTAL SAFETY FOR THE OPERATOR.

AVAILABLE WITH MECHANICAL TRANSMISSION OR CONTINUOUSLY VARIABLE HYDROSTATIC TRANSMISSION, ALL MODELS ARE EQUIPPED WITH A REVERSIBLE HANDLEBAR TO BE USED BOTH WITH REAR AND FRONT-MOUNTED ATTACHMENTS.

# 4 SEASONS SOLUTION

# UNIQUE

SEVERAL ADVANTAGES MAKE THE FERRARI TWO-WHEEL TRACTORS EXCLUSIVE

MADE IN ITALY



**PARKING BRAKE**  
as standard on all models.

**GEARBOX**  
with gear in oil bath, which guarantees long life and reliability.

**QUICK HITCHES**  
as optional for the replacement of the attachments without using any wrench.

**POWERSAFE® HYDRAULIC CLUTCH**  
with multiple discs in oil bath.

**MECHANICAL TRANSMISSION**  
with quick reverser of the forwarding direction.

**DIFFERENTIAL WITH LOCK**  
for improved traction and manoeuvrability.

**DRIVER'S POSITION**  
with adjustable and reversible 180° handlebar, mounted on silent blocks to dampen vibrations.

**INDEPENDENT POWER TAKE-OFF**  
with maintenance-free coupling in oil bath.

**HYDROSTATIC TRANSMISSION**  
with EasyGrip forwarding control.

**ENGINE COVER**  
to improve the machine appearance.

**PROFESSIONAL ENGINES**  
featuring a high torque reserve assure they hold up even under the most difficult conditions and during prolonged use.



# HIGH-PERFORMING

THE PATENTED MULTI-DISC OIL-BATH CLUTCH WITH HYDRAULIC ACTUATION, FITTED ON THE ENTIRE RANGE OF FERRARI TWO-WHEEL TRACTORS, ENSURES NOT ONLY MAXIMUM RELIABILITY BUT ALSO GREATER OPERATING COMFORT, SAFETY, AND HIGH PERFORMANCE UNDER ANY WORKING CONDITIONS.



## PERFORMANCE

- No overheating even if stressed for a long time.
- Smoother engagement.
- No drop in performance at any operating temperature.



## RELIABILITY

- Simplified maintenance.
- Practically unlimited duration even if stressed with attachments moving alternately such as cutter bars or with high inertia such as heavy-duty mowers.



## SAFETY

- Built-in brake that immediately stops the machine and attachment if the handlebar is accidentally released.
- Dual action is required to resume work in total safety: the system consists in pulling the clutch lever before being able to lower the hold-to-run lever.



## COMFORT

- Elimination of preliminary action for engine start-up: after releasing the handlebar, the engine continues running for subsequent work resumption.
- Ergonomic clutch lever and smooth to operate by acting on the hydraulic control valve and not on a spring as in traditional clutches.

# THE RANGE

A COMPLETE RANGE OF REVERSIBLE AND MULTIFUNCTIONAL TWO-WHEEL TRACTORS, EACH WITH DIFFERENT POWER LEVELS, SIZES, AND TECHNICAL FEATURES TO MEET THE MOST DIVERSE WORK REQUIREMENTS 365 DAYS A YEAR.



**380<sup>HY</sup>**  
STAR<sup>GATE</sup>



**306**  
PowerSafe<sup>®</sup>  
SMART



**328**  
PowerSafe<sup>®</sup>



**360**  
PowerSafe<sup>®</sup>



**338**  
PowerSafe<sup>®</sup>



**340**  
PowerSafe<sup>®</sup>

# 306

PowerSafe®  
SMART

REVERSIBLE TWO-WHEEL TRACTOR WITH MECHANICAL TRANSMISSION AND POWERSAFE® HYDRAULIC CLUTCH.

306 PowerSafe® is a small, lightweight two-wheel tractor, compact in size and with essential features, designed for beginners and for those with very simple work requirements.

Created for working in small vegetable gardens, private gardens, greenhouses, or confined spaces, it is the ideal model for those who are new to this type of agricultural machine or for those with a limited budget who do not want to give up the qualities of a FERRARI product: ease of use, reliability, and safety.

Engine	Fuel	Starter	Power kW/hp
GENKINS GK210	Gasoline	Recoil	4,4 / 5,9

 **NO. OF SPEEDS**  
1 + 1

 **DIFFERENTIAL**  
No

 **POWER**  
5,9 hp

 **MAX. TILLING WIDTH**  
52 cm

GRAPH OF THE SPEEDS IN KM/H WITH 3.50-8 WHEELS



GRAPH OF THE SPEEDS IN KM/H WITH 4.0-10 WHEELS





TWO-WHEEL TRACTORS

# 328 PowerSafe®

REVERSIBLE TWO-WHEEL TRACTOR WITH MECHANICAL TRANSMISSION AND POWERSAFE® HYDRAULIC CLUTCH.

328 PowerSafe® is a compact and lightweight two-wheel tractor, designed to provide safety and ease of use even for less experienced operators.

Creating and maintaining vegetable gardens and private lawns, mowing grass and weeds on small plots or in confined areas, and clearing snow from driveways are just some of the many tasks 328 PowerSafe® can easily handle.

Engine	Fuel	Starter	Power kW/hp
HONDA GP160	Gasoline	Recoil	3,6 / 4,8
HONDA GX200	Gasoline	Recoil	4,1 / 5,5
HONDA GX270	Gasoline	Recoil	6,3 / 8,6

 **NO. OF SPEEDS**  
3 + 3

 **DIFFERENTIAL**  
No

 **MAX. POWER**  
8,6 hp

 **MAX. TILLING WIDTH**  
66 cm

GRAPH OF THE SPEEDS IN KM/H WITH 4.0-10 WHEELS

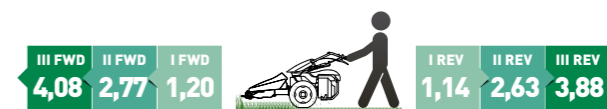

# 338 PowerSafe®

REVERSIBLE TWO-WHEEL TRACTOR WITH MECHANICAL TRANSMISSION AND POWERSAFE® HYDRAULIC CLUTCH.

338 PowerSafe® is a professional two-wheel tractor intended for farmers and demanding individuals.

It makes it possible to fulfil all requests in soil preparation, inter-row mowing in vineyards and orchards, in the clearing of uncultivated areas, in the removal of snow and in the care of gardens on medium and large-sized areas.

The presence of the differential provides greater maneuverability of the two-wheel tractor and, inserting the lock using the lever on the handlebar, provides greater adherence to the ground and easy straight forward motion.

Engine	Fuel	Starter	Power kW/hp
HONDA GX270	Gasoline	Recoil or Electric	6,3 / 8,6
HONDA GX340	Gasoline	Recoil	8 / 10,7
KOHLER KD350	Diesel	Recoil or Electric	5,5 / 7,5

 **NO. OF SPEEDS**  
3 + 3

 **DIFFERENTIAL**  
Yes

 **MAX. POWER**  
10,7 hp

 **MAX. TILLING WIDTH**  
66 cm

### GRAPH OF THE SPEEDS IN KM/H WITH 5.0-10 WHEELS

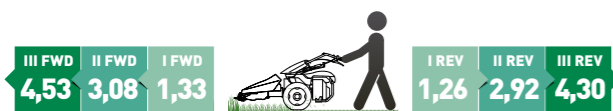





TWO-WHEEL TRACTORS

# 340 PowerSafe®

REVERSIBLE TWO-WHEEL TRACTOR WITH MECHANICAL TRANSMISSION AND POWERSAFE® HYDRAULIC CLUTCH.

340 PowerSafe® is a professional two-wheel tractor designed for intensive use.

Ideal for the creation of vegetable gardens, the maintenance of public and private gardens, snow removal, mowing and inter-row cleaning of vineyards, orchards or large uncultivated areas.

The presence of the differential increases maneuverability and, combined with the brakes, makes the two-wheel tractor agile even when moving on slopes.

Drum brakes as standard make it possible to independently brake one wheel at a time to improve steering.

Engine	Fuel	Starter	Power kW/hp
HONDA GX390	Gasoline	Recoil or Electric	8,7 / 11,7
YANMAR L100V	Diesel	Recoil or Electric	6,8 / 9,1
KOHLER KD440	Diesel (with air filter in oil bath)	Electric	8 / 10,5

 **NO. OF SPEEDS**  
3 + 3

 **DIFFERENTIAL**  
Yes

 **MAX. POWER**  
11,7 hp

 **MAX. TILLING WIDTH**  
80 cm

GRAPH OF THE SPEEDS IN KM/H WITH 5.0-10 WHEELS

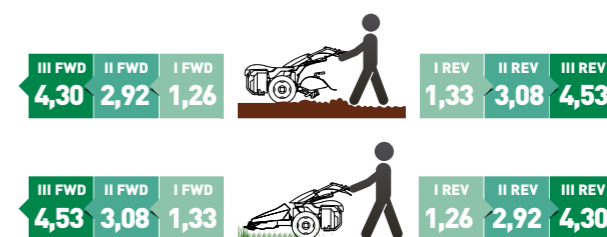

# 360

## PowerSafe®

REVERSIBLE TWO-WHEEL TRACTOR WITH MECHANICAL TRANSMISSION AND POWERSAFE® HYDRAULIC CLUTCH.

360 PowerSafe® is a super-professional two-wheel tractor, designed for full-time farmers and garden caretakers.

It's ideal for agricultural work of ploughing and tilling the soil, inter-row mowing of vineyards and orchards, care of gardens in large areas and on particularly rough land.

The cascade reduction units of gears on the two wheels, the reinforced PTO, the differential with lock and independent brakes make 360 PowerSafe® a real 2-wheel tractor.

In addition, the standard quick hitch makes it possible to replace the attachments without using spanners.

Engine	Fuel	Starter	Power kW/hp
HONDA GX390	Gasoline	Recoil or Electric	8,7 / 11,7
KOHLER KD440	Diesel (with air filter in oil bath)	Recoil or Electric	8 / 10,5

 **NO. OF SPEEDS**  
3 + 3

 **DIFFERENTIAL**  
Yes

 **MAX. POWER**  
11,7 hp

 **MAX. TILLING WIDTH**  
85 cm

### GRAPH OF THE SPEEDS IN KM/H WITH 6.5/80-12 WHEELS

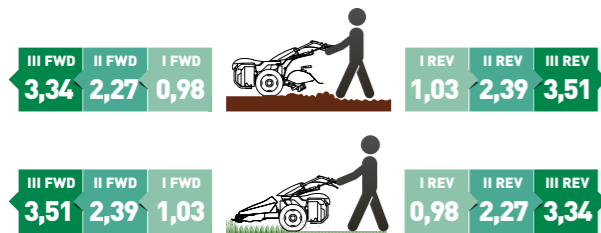



**TWO-WHEEL TRACTORS**

# 380<sup>HY</sup> STARGATE

**REVERSIBLE TWO-WHEEL TRACTOR WITH HYDROSTATIC TRANSMISSION (CVT) AND POWERSAFE® HYDRAULIC CLUTCH.**

380 HY StarGate is a newly designed hydrostatic two-wheel tractor.

Multifunctional and intuitive, it makes the continuously variable transmission concept accessible to a wide range of users: from advanced hobby farmers to professional farmers, from private individuals to green-space maintenance professionals.

The completely redesigned driving position ensures even simpler and more comfortable use of the two-wheel tractor, both with rear and front implements.

The engine cover, fitted as standard, further enhances the machine's modern and attractive design.



**NO. OF SPEEDS**  
One-speed range



**DIFFERENTIAL**  
Yes



**MAX. POWER**  
11,7 hp



**MAX. TILLING WIDTH**  
80 cm

Engine	Fuel	Starter	Power kW/hp
HONDA GX390	Gasoline	Recoil or Electric	8,7 / 11,7
YANMAR L100V	Diesel	Recoil or Electric	6,8 / 9,1

**GRAPH OF THE SPEEDS IN KM/H WITH 5.0-10 WHEELS**

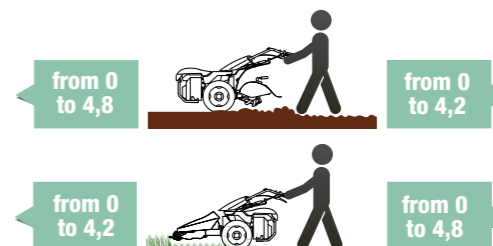

## THE ADVANTAGES OF HYDROSTATIC TRANSMISSION

The Continuously Variable Transmission, unlike the mechanical transmission, allows the direction of travel to be reversed and the forward speed to be precisely adjusted to cope with sudden changes in work conditions, without having to stop and without having to operate the clutch, gearbox or inverter lever.

Using only the EasyGrip lever on the handlebar, the operator can increase or decrease the speed of the two-wheel tractor depending on ground conditions, grass density or snow compactness, or quickly reverse direction to manoeuvre around trees or obstacles.

Speed variation and reversing also occur independently of the PTO and engine speed, which means that the implement is always working at maximum speed.

# TANGIBLE BENEFITS

## MAXIMUM COMFORT AND REDUCED FATIGUE

Continuous speed adjustment eliminates the need to stop for gear changes or directional shifts, reducing physical strain. Operations become smoother and less tiring, making work more comfortable.

## UNMATCHED PRECISION

The ability to fine-tune speed allows the operator to find the perfect pace for any task and any equipment. This results in consistently optimal job quality.

## INSTANT ADAPTABILITY

The EasyGrip lever enables immediate response to changing working conditions. Maneuvering around obstacles, trees, or field edges becomes quick and intuitive – even for less experienced users.

## OPTIMIZED IMPLEMENT EFFICIENCY

Thanks to the PTO being independent of forward speed, the implement always operates at optimal RPM, even with the machine stationary. This ensures higher performance and zero power loss.

## INCREASED PRODUCTIVITY

Fewer interruptions for gear changes and faster maneuvers translate into more efficient work, saving both time and fuel.

The StarGate transmission is not just a technological innovation; it's the foundation for greater efficiency, comfort, and top-tier results for every professional working in specialized agriculture, horticulture, nursery management, landscaping, and municipal operations.



# ATTACHMENTS

FERRARI TWO-WHEEL TRACTORS CAN BE USED FOR DIFFERENT WORKS, AS WELL AS FOR CLASSIC TILLING.

THE REVERSIBILITY OF THE HANDLEBARS, COMBINED WITH THE CORRECT RATIO BETWEEN THE FORWARD SPEEDS AND THE INDEPENDENT POWER TAKE-OFF SPEED, ENABLES ALL THE MODELS TO BE USED IN AN EXTREMELY PROFESSIONAL WAY WITH BOTH FRONT AND REAR ATTACHMENTS.

THE WIDE RANGE OF GENUINE ATTACHMENTS MAKES FERRARI TWO-WHEEL TRACTORS INDISPENSABLE TOOLS FOR ALL SEASONS.



# ROTARY HOE



## USE

Attachment for tilling the soil in preparation for seeding, for burying vegetable residues, eliminating weeds or for weeding between rows in vegetable crops and floriculture.

## TECHNICAL FEATURES

Minimum power required\*: 3,5 kW (46 cm) - 4,5 kW (52 cm) - 5,5 kW (66 cm) - 7,5 kW (80 cm) - 8 kW (85 cm).

Transmission with gears in oil bath.

Adjustable working depth (not available for 46-cm model).

The tilling width can be adjusted by changing the numbers of knives and the width of the cover (not available for 46-cm model).

Work safety guard for operator safety.

Optional: travel wheel, Precision Depth Roller, ridger behind rotary hoe.

\* data purely approximate and referred to standard working conditions

## AVAILABLE VERSIONS

Working width: 46 - 52 - 66 - 80 - 85 cm.

# PRECISION DEPTH ROLLER



## USE

Fitted behind the rotary hoe, the roller allows the tilling depth to be adjusted with extreme precision and the sowing bed to be prepared by levelling the top layer of the soil.

## TECHNICAL FEATURES

Rotary hoe work depth adjustment: from 1 cm to the maximum tilling depth.

Steel roller with holes supported by self-lubricating metal bushings.

## AVAILABLE VERSIONS

For 66 and 80 cm rotary hoe.

# RIDGER



## USE

Attachment for creating a furrow in previously tilled soil, opening small drainage ditches and reinforcing row crops.

## TECHNICAL FEATURES

Cutting angle of the plough adjustable through the dedicated link.

Cutting depth of the plough adjustable through the dedicated adjustment screw.

Ridge depth adjustable by opening the mouldboards.

Max width of the ridge: 38.5 cm (41 cm ridger for 360 PowerSafe® two-wheel tractor).

Recommended accessories: 6.5/80-12 wheels and relative weights.

# RIDGER BEHIND ROTARY HOE

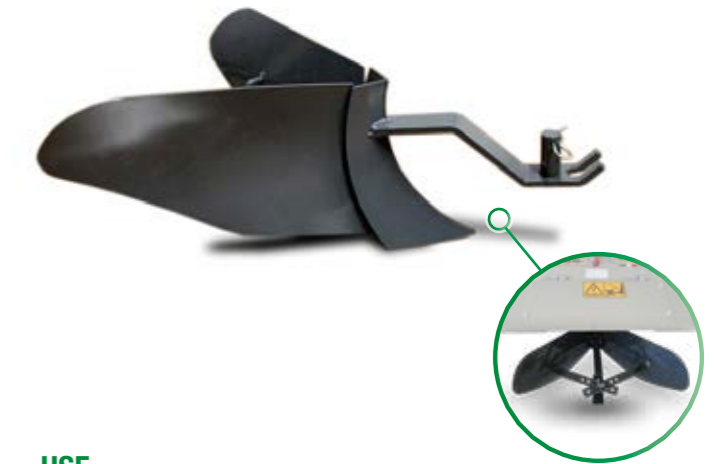

## USE

Mounted behind the rotary hoe, it is the attachment for creating a furrow, opening small drainage ditches or reinforcing row crops.

## TECHNICAL FEATURES

Ridge depth adjustable by opening the mouldboards.

Max width of the ridge: 59 cm.

## PLOUGH

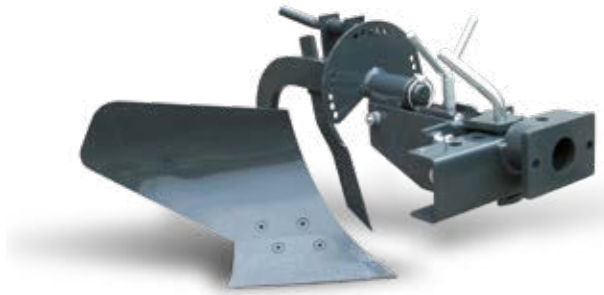

### USE

Attachment for tilling and turning over the soil for subsequent processing or directly for sowing. In turning the soil, weeds and previous crops are buried, speeding up their decomposition.

### TECHNICAL FEATURES

Working width: 20 cm.

Cutting depth of the plough: adjustable through the dedicated adjustment screw.

Height of the knife: adjustable.

Working angle: adjustable through the dedicated lever.

Recommended accessories: 6.5/80-12 wheels and relative weights.

## SWIVEL PLOUGH



### USE

Attachment for tilling and turning over the soil for subsequent processing or directly for sowing. The 180° swivel plough allows overturning the soil always on the same side, both along the forward and return passage.

### TECHNICAL FEATURES

Working width: 20 cm.

Two mouldboards rotatable through 180 ° by lever.

Cutting depth of the plough: adjustable through the dedicated adjustment screw.

Height of the knife: adjustable.

Working angle: adjustable through the dedicated lever.

Recommended accessories: 6.5/80-12 wheels and relative weights.

## ROTARY PLOUGH GROUNDBLASTER



### USE

Attachment for preparing the soil for sowing by integrating ploughing and tilling in a single step, for eliminating weeds, for the tillage of small areas to be cultivated, for creation of furrows, by performing multiple passes.

### TECHNICAL FEATURES

Working width: 25 cm.

Minimum power required\*: 6,3 kW.

Transmission with gears in oil bath.

Tubular work safety protection for operator safety.

Working depth: adjustable from the rear support wheel.

Side sheet panel supplied for obtaining ridge-free cultivation and to prevent any dropping of the soil onto the nearby crops.

Optional: 5-kg each stackable weights.

\* data purely approximate and referred to standard working conditions

## GROUNDBLASTER SWIVEL ROTARY PLOUGH



### USE

Attachment for preparing the soil for sowing by integrating ploughing and tilling in a single step, to turn up new pieces of land for farming. The 180° swivel rotary plough allows overturning the soil always on the same side, both along the forward and return passage.

### TECHNICAL FEATURES

Working width: 25 cm.

Minimum power required\*: 6,3 kW.

Two ploughshares that rotate with a lever.

Transmission with gears in oil bath.

Tubular work safety protection for operator safety.

Adjustable working depth with the rear supporting wheel.

\* data purely approximate and referred to standard working conditions

## RIDGER RIDGE 2



### USE

Specific front attachment for ridging by removing the earth from the inter-row and placing it at the bottom of the plant or clearing weeds from the furrow.

### TECHNICAL FEATURES

Plant inter-row spacing: 90 cm (standard) - 130 cm (with extensions).

Minimum power required\*: 5,5 kW.

Transmission with gears in oil bath.

Working depth: adjustable from the little front wheel.

Working width: adjustable from the upper wings.

Optional: pair of extensions, 30-kg weight.

\* data purely approximate and referred to standard working conditions

### AVAILABLE VERSIONS

Width of the worked field: 48 - 60 cm.

## POWER HARROW

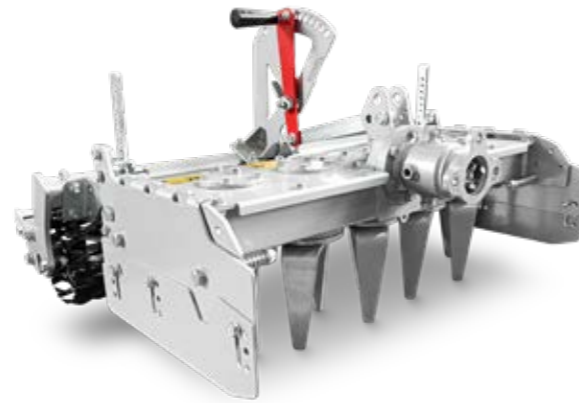

### USE

Soil milling and leveling in a single operation for the preparation of a fine and homogeneous seedbed when creating new vegetable gardens, lawns, and gardens.

### TECHNICAL FEATURES

Working width: 75 cm.

Minimum power required\*: 6.3 kW.

Adjustable steel mesh rear roller.

Working depth adjustable via quick-change roller lever.

Rotors supported by two bearings each.

Closed round fork with anti-clogging function and protection of the internal rotor parts.

Rear bar for adjusting the refinement of worked soil.

PTO hitch adjustable in fixed or oscillating position.

Side skids with shock absorption, adjustable to three fixed positions and one floating position.

\* data purely approximate and referred to standard working conditions

## MULCHING MACHINE PM-F 100



### USE

Laying of mulch sheets on the previously tilled and perfectly levelled ground.

### TECHNICAL FEATURES

Fixed chassis.

Sheet width: 60 to 100 cm.

Wheels, front and rear ploughshares adjustable for optimal implement fielding.

Optional: hose reel kit.

Recommended accessories: wheel weights, cage wheels.

## MULCHING MACHINE PM-A 100

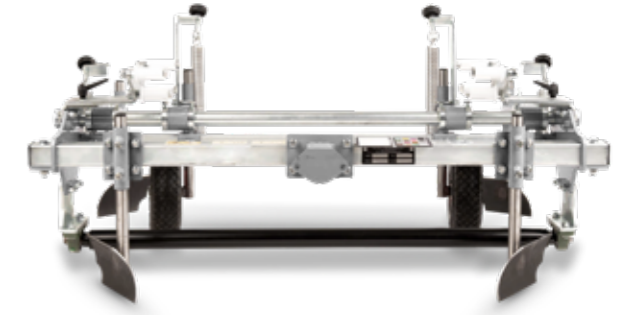

### USE

Professional laying of mulch sheets on previously tilled soil. The shock-absorbing chassis allows optimal ground adaptation in the event of depressions.

### TECHNICAL FEATURES

Chassis with preload springs connected to the wheels and swing arms of the rear ploughshares.

Sheet width: 80 to 100 cm.

Wheels, front and rear ploughshares adjustable for optimal implement fielding.

The spring tension is also adjustable via the adjustment knobs.

Optional: hose reel kit.

Recommended accessories: wheel weights, cage wheels.



## CUTTER BAR



### USE

Attachment for cutting grass and forage without collection on any flat, hilly or mountain ground.

### TECHNICAL FEATURES

Cutting widths from 80 to 210 cm.

Slides for cutting height adjustment.

Full thickness screws in the blade base in alloy and tempered steel.

Blade attachment with reinforced tempered steel bridge.

Self-adjusting blade-holders (for Duplex and Dual Laser® Elasto only).

Optional: transmission unit 12-kg weight.

### AVAILABLE VERSIONS

Laser® - with middle cut fingers - Duplex - Dual Laser® with standard or Elasto blade holders.

Transmission in oil bath - Transmission in oil bath with double movement.

## SINGLE-BLADE LAWN MOWER



### USE

Attachment for cutting grass with grass collector, maintenance of green areas and small public or private gardens.

### TECHNICAL FEATURES

Cutting width: 56 cm.

Minimum power required\*: 3,6 kW.

Transmission with gears in oil bath.

Front wheels for maximum maneuverability.

Cutting height: adjustable by lever.

Automatic blade brake, according to EN 12733 standard.

Grass catcher: 60 litres capacity.

\* data purely approximate and referred to standard working conditions

## 2-BLADE LAWN MOWER



### USE

Attachment for cutting grass with grass collector, professional maintenance of parks, sports fields, public and private gardens.

### TECHNICAL FEATURES

Cutting width: 100 cm.

Minimum power required\*: 7,5 kW.

Transmission with gears in oil bath.

Anti-dragging free wheel and automatic blade brake, according to the EN 12733 standard.

Pivoting blades.

Adjustable front wheels for the horizontal adjustment of the cutting unit.

Cutting height: adjustable by lever.

Grass catcher: 160 litres capacity.

\* data purely approximate and referred to standard working conditions

## SINGLE-BLADE HEAVY-DUTY MOWER



### USE

Attachment for rough cutting with discharge to the ground of grass, shrubs, scrub on uncultivated and undergrowth areas.

### TECHNICAL FEATURES

Cutting width: 80 cm.

Minimum power required\*: 7 kW.

Automatic blade brake according to the EN 12733 standard and anti-dragging free wheel.

Transmission with gears in oil bath.

Swinging axle.

Front pivoting wheels and adjustable for the horizontal setting of the cutting unit.

Cutting height: adjustable through suitable spacers.

\* data purely approximate and referred to standard working conditions

# HEAVY-DUTY MOWER BLADERUNNER



## USE

Attachment for the heavy-duty maintenance and clearing from brambles, bushes and underbrush of uncultivated land or also for eliminating pruning residues or for controlling weeds between rows.

## TECHNICAL FEATURES

Single-rotor heavy duty mower with "Y"-shaped mobile blades.

Minimum power required\*: 5 kW (60 cm) - 6 kW (75 cm) - 7,5 kW (90 cm) - 8,5 kW (110 cm).

Automatic blade brake according to the EN 12733 standard and anti-dragging free wheel.

Main transmission with gears in oil bath and lateral transmission with belts.

Mobile front opening with canvas and protection bar.

Front pivoting wheels. They can be locked for processing on slopes (for 90 and 110 cm models only).

Cutting height: constantly adjustable by crank.

Optional: lawn mower blades, rear anti-scalp roller, 14-kg weight.

\* data purely approximate and referred to standard working conditions

## AVAILABLE VERSIONS

Cutting width: 60 - 75 - 90 - 110 cm.

# HEAVY-DUTY MOWER ROLLERBLADE



## USE

Attachment for eliminating pruning residues and for controlling weeds between rows, for the heavy-duty maintenance and clearing from brambles, bushes and underbrush of uncultivated land, even in sloping areas.

## TECHNICAL FEATURES

Single-rotor heavy duty mower with "Y"-shaped mobile blades.

Minimum power required\*: 6 kW (75 cm) - 7,5 kW (90 cm).

Automatic blade brake according to the EN 12733 standard and anti-dragging free wheel.

Main transmission with gears in oil bath and lateral transmission with belts.

Front opening protected by mobile steel flaps.

Standard rear anti-scalp roller.

Cutting height: constantly adjustable by crank.

Optional: lawn mower blades.

\* data purely approximate and referred to standard working conditions

## AVAILABLE VERSIONS

Cutting width: 75 - 90 cm.

# SNOW BLADE



## USE

Attachment for professional snow removal from any surface, gravel or sand handling.

## TECHNICAL FEATURES

Working width: 100 cm.

Steel structure.

Curved shape to facilitate the rolling of the snow.

Orientated laterally directly from the driver position.

Adjustable ground clearance.

Optional: 9-kg weight, soft blade kit.

# DOZER BLADE



## USE

Attachment for moving and levelling gravel, sand or soil and for removing snow from coarse surfaces.

## TECHNICAL FEATURES

Working width: 92 cm.

Steel structure.

Laterally oriented.

Used both for pushing and leveling.

# TURBINE SNOW THROWER



## USE

Attachment for removing snow from avenues, pavements and parking lots quickly and effortlessly by collecting and throwing snow.

## TECHNICAL FEATURES

Minimum power required\*: 5 kW (60 cm) - 6 kW (75 cm).

Transmission with gears in oil bath and cast-iron housing.

Duct made of stainless steel and pivoting by 180° directly from the driving position.

Adjustable skids to set the ground clearance.

Safety pins to prevent damage to the impellers in case of impact.

Optional: 5 kg balancing weight.

\* data purely approximate and referred to standard working conditions

## AVAILABLE VERSIONS

Working width: 60 - 70 cm.

# SWEEPER

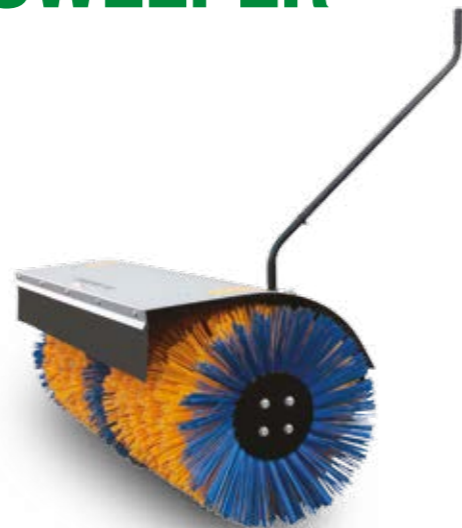

## USE

Attachment for superficial clearing of snow or cleaning driveways, pavements, parking lots and barns.

## TECHNICAL FEATURES

Minimum power required\*: 6,3 kW.

Transmission with gears in oil bath and cast-iron housing.

Brush: nylon or nylon and steel (for 100 and 120 cm models only).

Rear wheels for better maneuverability.

Sideways adjustable directly from the driving position.

Adjustable cleaning height.

\* data purely approximate and referred to standard working conditions

## AVAILABLE VERSIONS

Working width: 80 - 100 - 120 cm.

# PNEUMATIC WHEELS



## USE

Pneumatic wheels with different dimensions and profiles for various types of applications in agriculture, greens maintenance or haymaking.

## TECHNICAL FEATURES

Tractor: agricultural use. The thread lug design also allows a good grip on hard and soft terrain.

Lug Tyre: agricultural use. The thread lug design always ensures good grip but with less soil compaction.

Terra Tyre: used for greens maintenance and haymaking. The widened profile allows greater flotation and minimum soil compaction.

Garden: used for greens maintenance on finer surfaces. The low compaction profile protects the turf.

# METAL WHEELS



## USE

Iron wheels fitted instead of pneumatic wheels for various types of use in the agricultural field.

## TECHNICAL FEATURES

Steel cage: agricultural use on very hard soils. The crosspieces penetrate into the ground preventing the wheels from slipping. Steel cage wheels can also be used on loose and soft soils where the pneumatic wheels could sink.

Twinning rings: coupled to the cage wheels, they double the support surface and anchorage on the ground.

## WHEEL WEIGHTS



### USE

Secured to the wheel hubs, they are used to weigh down the two-wheel tractor and therefore provide greater traction, enhancing performance and safety levels.

## WHEEL SPACERS



### USE

The wheel spacers are designed to widen the machine's track by 6 cm on either side, thereby improving its stability on cross slopes or on rough terrain.

## QUICK HITCH



### USE

Comprising a tang and a bush, the quick hitch is the ideal accessory to change attachments quickly and easily, without having to use any spanners.

Standard on 360 PowerSafe® two-wheel tractor.

## PTO EXTENSION



### USE

A useful accessory to balance the weight between the machine and the attachment. One or more 8 cm extensions can be fitted to distance the attachment from the two-wheel tractor and increase its ground weight or to prevent the attachment from interfering with the wheels.

## ROTARY HOE TRAVEL WHEEL



### USE

Mounted behind any FERRARI rotary hoe, it makes transporting the two-wheel tractor to the field easier and less tiring.

## TWIN WHEEL KIT



### USE

It allows two wheels to be twinned, increasing traction on the ground or improving the stability of the two-wheel tractor on cross slopes.

## PTO ADAPTERS



### USE

They allow the mounting of tools with a Z10 grooved PTO coupling on new machines with a 3-tooth PTO coupling, and vice versa.

## TRACTOR PTO COUPLER



### USE

Applied to the machine's standard PTO, it carries a splined shaft on the outside like the tractor PTO, allowing the connection of cardan joints, pulleys, spray pumps and various implements.

## ENGINE COVER



### USE

FERRARI two-wheel tractors can also have an engine bonnet, which improves the machine appearance.

Available for Honda, Kohler and Yanmar engines.

Standard on 380 HY StarGate two-wheel tractor.

## LUBRICANTS



### USE

The original PowerLube lubricants are the only ones that guarantee both the hydraulic and mechanical components of the FERRARI two-wheel tractors function properly and, at the same time, ensuring their perfect efficiency over time.

### TECHNICAL FEATURES

High quality synthetic bases and raw materials.

Formulated specifically for FERRARI two-wheel tractors.

### AVAILABLE VERSIONS

Mechanical and hydromechanical transmission lubricant -  
Hydrostatic transmission and engine lubricant.

## FERRARI ORIGINAL SPARE PARTS



### USE

Only by using original spare parts will you be sure to maintain the performance of your FERRARI two-wheel tractor.

All FERRARI two-wheel tractors offer high performance every day in total safety and you will surely want them to continue working as they did on the first day, providing the same performance and reliability.

That is why you should choose only original FERRARI spare parts made by those who design and build the machines, control the processes and guarantee high quality standards.

# TECHNICAL FEATURES

	Engine	Fuel	Starter	Power kW/hp	Transmission	Speeds FWD+REV	Quick reverser	Clutch	Brakes	Differential	PTO	Handlebar	Available wheels	Safety devices	Ferrari attachments which can be mounted
<b>306</b> PowerSafe® SMART	GENKINS GK210	Gasoline	Recoil	4,4 / 5,9	Mechanical, with gears and worm screw in oil bath	1 + 1	No	PowerSafe®, hydraulically operated with multiple discs in oil bath	No	No	Independent from gearbox. At 990 rpm (with engine at 3600 rpm) with engagement in oil bath	Mounted on silent-blocks, adjustable in height, sideways and reversible	3.50-8 4.00-8 4.0-10 Steel cage wheels Ø43 cm	In compliance with the EN 709/A4 standard	Rotary hoe, cutter bar, lawn mower, snow blade, sweeper
<b>328</b> PowerSafe®	HONDA GP160	Gasoline	Recoil	3,6 / 4,8	Mechanical, with gears and worm screw in oil bath	3 + 3	Yes, with mechanical control on the handlebar	PowerSafe®, hydraulically operated with multiple discs in oil bath	Parking brake	No	Independent from gearbox. At 990 rpm (with engine at 3600 rpm) with engagement in oil bath	Mounted on silent-blocks, adjustable in height, sideways and reversible	4.00-8 4.0-10 5.0-10 5.0-12 6.5/80-12 Steel cage wheels Ø43 cm	In compliance with the EN 709/A4 standard	Rotary hoe, PDR, ridger, plough, cutter bar, lawn mower, BladeRunner, RollerBlade, snow blade and turbine snow thrower, sweeper
	HONDA GX200	Gasoline	Recoil	4,1 / 5,5											
	HONDA GX270	Gasoline	Recoil	6,3 / 8,6											
<b>338</b> PowerSafe®	HONDA GX270	Gasoline	Recoil or electric	6,3 / 8,6	Mechanical, with gears and worm screw in oil bath	3 + 3	Yes, with mechanical control on the handlebar	PowerSafe®, hydraulically operated with multiple discs in oil bath	Parking brake on the two wheels	With lock	Independent from gearbox. At 990 rpm (with engine at 3600 rpm) with engagement in oil bath	Mounted on silent-blocks, adjustable in height, sideways and reversible	5.0-10 5.0-12 6.5/80-12 Steel cage wheels Ø 49 cm	In compliance with the EN 709/A4 standard	Rotary hoe, PDR, ridger, plough, GroundBlaster, Ridge 2, mulching machine, cutter bar, lawn mower, heavy-duty mower, BladeRunner, RollerBlade, snow blade and turbine snow thrower, sweeper
	HONDA GX340	Gasoline	Recoil	8 / 10,7											
	KOHLER KD350	Diesel	Recoil or electric	5,5 / 7,5											
<b>340</b> PowerSafe®	HONDA GX390	Gasoline	Recoil or electric	8,7 / 11,7	Mechanical, with gears and worm screw in oil bath	3 + 3	Yes, with mechanical control on the handlebar	PowerSafe®, hydraulically operated with multiple discs in oil bath	Independent working brakes on the two wheels and parking brake	With lock	Independent from gearbox. At 990 rpm (with engine at 3600 rpm) with engagement in oil bath	Mounted on silent-blocks, adjustable in height, sideways and reversible	5.0-10 5.0-12 6.5/80-12 6.5/80-15 Steel cage wheels Ø 49 cm	In compliance with the EN 709/A4 standard	Rotary hoe, PDR, ridger, plough, GroundBlaster, Ridge 2, mulching machine, cutter bar, lawn mower, heavy-duty mower, BladeRunner, RollerBlade, snow blade and turbine snow thrower, sweeper
	YANMAR L100V	Diesel	Recoil or electric	6,8 / 9,1											
	KOHLER KD440	Diesel (with air filter in oil bath)	Electric	8 / 10,5											
<b>360</b> PowerSafe®	HONDA GX390	Gasoline	Recoil or electric	8,7 / 11,7	Mechanical, with gears and worm screw in oil bath	3 + 3	Yes, with mechanical control on the handlebar	PowerSafe®, hydraulically operated with multiple discs in oil bath	Independent working brakes on the two wheels and parking brake	With lock	Independent from gearbox. At 990 rpm (with engine at 3600 rpm) with engagement in oil bath	Mounted on silent-blocks, adjustable in height, sideways and reversible	6.5/80-12 6.5/80-15 Steel cage wheels Ø 58 cm	In compliance with the EN 709/A4 standard	Rotary hoe, ridger, plough, mulching machine, lawn mower, heavy-duty mower, BladeRunner, RollerBlade, sweeper
	KOHLER KD440	Diesel (with air filter in oil bath)	Recoil or electric	8 / 10,5											
<b>380HY</b> STARGATE	HONDA GX390	Gasoline	Recoil or electric	8,7 / 11,7	Hydrostatic StarGate, with final worm screw reduction in oil bath	One-speed range in both FWD and REV	Yes, by hydrostatic unit with EasyGrip lever on the handlebar	PowerSafe®, hydraulically operated with multiple discs in oil bath	Independent working brakes on the two wheels and parking brake	With lock	Independent from gearbox. At 990 rpm (with engine at 3600 rpm) with engagement in oil bath	Mounted on silent-blocks, adjustable in height, sideways and reversible	5.0-10 5.0-12 6.5/80-12 6.5/80-15 Steel cage wheels Ø 49 cm	In compliance with the EN 709/A4 standard	Rotary hoe, PDR, ridger, plough, GroundBlaster, Ridge 2, mulching machine, cutter bar, lawn mower, heavy-duty mower, BladeRunner, RollerBlade, snow blade and turbine snow thrower, sweeper
	YANMAR L100V	Diesel	Recoil or electric	6,8 / 9,1											

For more info, size and weights go to [www.ferrariagri.com](http://www.ferrariagri.com)

## THE SERVICES

---



### SPARE PARTS

A complete range of original spare parts, guaranteed directly by the manufacturer.



### ASSISTANCE

A team of specialists, well prepared and available to assure an efficient and resolving service.



### LUBRICANTS

We recommend to use the original PowerLube lubricants.

The information indicated in this folder is not binding. The models described may be modified, without notice, by the Manufacturer. The drawings and photos may refer to equipment that is either optional or intended for other countries. Please apply to our Sales Network for any further information. FERRARI guarantees the safety requirements according to the regulations only if the machine is used according to the instructions supplied and coupled with the FERRARI manufactured attachments. FERRARI declines any responsibility if any other attachment is used or in case of alteration and/or improper use.

MZ

10/25

90100701GB



MADE IN ITALY