



TWO-WHEEL TRACTORS

AND ATTACHMENTS

language



FERRARI

A COMPLETE RANGE OF PROFESSIONAL AND MULTIFUNCTIONAL TWO-WHEEL TRACTORS THAT ALLOW ALL THE FOLLOWING NEEDS TO BE FULFILLED, IN EVERY SEASON OF THE YEAR:

- SOIL PREPARATION FOR SOWING
- CARE OF GARDENS
- GREENS MAINTENANCE
- INTER-ROW MOWING OF VINEYARDS AND ORCHARDS
- CLEARING OF UNCULTIVATED AREAS
- CLEANING OF DRIVEWAYS OR BARNs
- SNOW REMOVAL

THANKS TO THE FERRARI TWO-WHEEL TRACTORS BEING SO SIMPLE TO HANDLE AND USE, THEY CAN BE USED BY A VAST RANGE OF USERS: FROM HOBBY FARMERS TO PROFESSIONAL FARMERS, AND FROM INDIVIDUALS TO THE GREENERY CARETAKER.

THE EXCLUSIVE OIL BATH CLUTCH ALSO GUARANTEES MAXIMUM RELIABILITY, COMFORT AND TOTAL SAFETY FOR THE OPERATOR.

AVAILABLE WITH MECHANICAL OR CONTINUOUSLY VARIABLE TRANSMISSION, ALL MODELS ARE EQUIPPED WITH A REVERSIBLE HANDLEBAR TO BE USED BOTH WITH REAR AND FRONT ATTACHMENTS.

4 SEASONS SOLUTION

UNIQUE

SEVERAL ADVANTAGES MAKE THE FERRARI TWO-WHEEL TRACTORS EXCLUSIVE

MADE IN ITALY



PARKING BRAKE
as standard on all models.

GEARBOX
with gear in oil bath, which guarantees long life and reliability.

QUICK HITCHES
as optional for the replacement of the attachments without using any wrench.

CLUTCH
with multiple discs in oil bath.

MECHANICAL TRANSMISSION
with quick reverser of the forwarding direction.

DIFFERENTIAL WITH LOCK
for improved traction and manoeuvrability.

DRIVER'S POSITION
with adjustable and reversible 180° handlebar, mounted on silent blocks to dampen vibrations.

INDEPENDENT POWER TAKE-OFF
with maintenance-free coupling in oil bath.

HYDROSTATIC TRANSMISSION
with EasyGrip forwarding control.

ENGINE COVER
to improve the machine appearance.

PROFESSIONAL ENGINES
featuring a high torque reserve assure they hold up even under the most difficult conditions and during prolonged use.



HIGH-PERFORMING

THE PATENTED CLUTCH WITH HYDRAULICALLY OPERATED MULTIPLE STEEL DISCS IN OIL BATH THAT IS FITTED ON POWERSAFE® AND STARGATE SERIES, NOT ONLY GUARANTEES MAXIMUM RELIABILITY BUT ALSO GREATER OPERATIONAL COMFORT, SAFETY AND HIGH PERFORMANCE IN ANY CONDITIONS OF USE.



PERFORMANCE

- No overheating even if stressed for a long time.
- Smoother engagement.
- No drop in performance at any operating temperature.



RELIABILITY

- Simplified maintenance.
- Practically unlimited duration even if stressed with attachments moving alternately such as cutter bars or with high inertia such as heavy-duty mowers.



SAFETY

- Built-in brake that immediately stops the machine and attachment if the handlebar is accidentally released.
- Dual action is required to resume work in total safety: the system consists in pulling the clutch lever before being able to lower the hold-to-run lever.



COMFORT

- Elimination of preliminary action for engine start-up: after releasing the handlebar, the engine continues running for subsequent work resumption.
- Ergonomic clutch lever and smooth to operate by acting on the hydraulic control valve and not on a spring as in traditional clutches.



WARRANTY

- Extended to 5 YEARS on the entire PowerSafe® clutch unit.

THE RANGE

6 MODELS, AVAILABLE WITH MECHANICAL OR CONTINUOUSLY VARIABLE TRANSMISSION, GASOLINE OR DIESEL ENGINES WITH MANUAL OR ELECTRIC STARTER, IN A TOTAL OF 22 DIFFERENT VERSIONS, EACH OF WHICH WITH UNIQUE TECHNICAL FEATURES TO SATISFY PRECISE REQUIREMENTS, 365 DAYS A YEAR.



380^{HY}
STAR^{GATE}



306
Smart^{Safe}®



328
Power^{Safe}®



360
Power^{Safe}®



338
Power^{Safe}®



340
Power^{Safe}®



TWO-WHEEL TRACTORS

306

SmartSafe®

REVERSIBLE TWO-WHEEL TRACTOR WITH MECHANICAL TRANSMISSION AND SMARTSAFE® CLUTCH IN OIL BATH.

306 SmartSafe® is a small two-wheel tractor with extremely low weight and dimensions, ideal for working on small private orchards and gardens, in tight spaces or in the greenhouses.

Tillage, grass cutting or snow removal are just some of the requirements that even the hobby-farmer can safely meet.

The SmartSafe® clutch, mechanically operated with multiple discs in oil bath, not only guarantees maximum reliability but also economy of operation.

Engine	Fuel	Starter	Power kW/hp
GENKINS GK210	Gasoline	Recoil	4,4 / 5,9



NO. OF SPEEDS
1 + 1



DIFFERENTIAL
No



MAX. POWER
5,9 hp



MAX. TILLING WIDTH
52 cm

GRAPH OF THE SPEEDS IN KM/H WITH 3.50-8 WHEELS

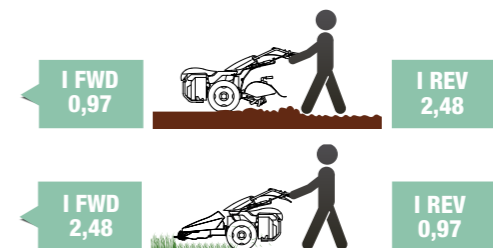

TWO-WHEEL TRACTORS

328 PowerSafe®

REVERSIBLE TWO-WHEEL TRACTOR WITH MECHANICAL TRANSMISSION AND POWERSAFE® HYDRAULIC CLUTCH.

328 PowerSafe® is a light and compact two-wheel tractor ideal for easily and safely working on small private plots or in tight spaces.

Creation of gardens, cutting of grass or scrub, removal of snow are only some of the needs that even the inexperienced operator will be able to satisfy.

 **NO. OF SPEEDS**
3 + 3

 **DIFFERENTIAL**
No

 **MAX. POWER**
8,6 hp

 **MAX. TILLING WIDTH**
66 cm

GRAPH OF THE SPEEDS IN KM/H WITH 4.0-10 WHEELS

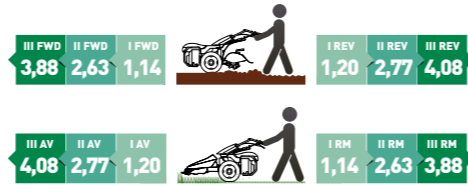

Engine	Fuel	Starter	Power kW/hp
HONDA GP160	Gasoline	Recoil	3,6 / 4,8
HONDA GX200	Gasoline	Recoil	4,1 / 5,5
HONDA GX270	Gasoline	Recoil	6,3 / 8,6



TWO-WHEEL TRACTORS

338 PowerSafe®

REVERSIBLE TWO-WHEEL TRACTOR WITH MECHANICAL TRANSMISSION AND POWERSAFE® HYDRAULIC CLUTCH.

338 PowerSafe® is a professional two-wheel tractor intended for farmers and demanding individuals.

It makes it possible to fulfil all requests in soil preparation, inter-row mowing in vineyards and orchards or in the clearing of uncultivated areas, in the removal of snow and in the care of gardens on medium and large-sized areas.

The presence of the differential provides greater manoeuvrability of the two-wheel tractor and, inserting the lock using the lever on the handlebar, provides greater adherence to the ground and easy straight forward motion.

 **NO. OF SPEEDS**
3 + 3

 **DIFFERENTIAL**
Yes

 **MAX. POWER**
10,7 hp

 **MAX. TILLING WIDTH**
66 cm

GRAPH OF THE SPEEDS IN KM/H WITH 5.0-10 WHEELS

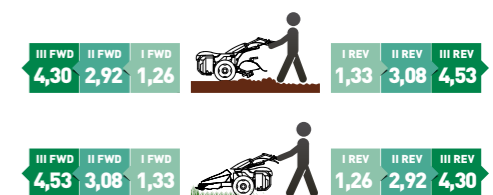

Engine	Fuel	Starter	Power kW/hp
HONDA GX270	Gasoline	Recoil or Electric	6,3 / 8,6
HONDA GX340	Gasoline	Recoil	8 / 10,7
KOHLER KD350	Diesel	Recoil or Electric	5,5 / 7,5



TWO-WHEEL TRACTORS

340 PowerSafe®

REVERSIBLE TWO-WHEEL TRACTOR WITH MECHANICAL TRANSMISSION AND POWERSAFE® HYDRAULIC CLUTCH.

340 PowerSafe® is a professional two-wheel tractor designed for intensive use.

Ideal for the creation of gardens, the maintenance of public and private gardens, snow removal, mowing and inter-row cleaning of vineyards, orchards or large uncultivated areas.

The presence of the differential increases manoeuvrability and, combined with the brakes, makes the two-wheel tractor agile even when moving on slopes.

Drum brakes as standard make it possible to independently brake one wheel at a time to improve steering.

-  **NO. OF SPEEDS**
3 + 3
-  **DIFFERENTIAL**
Yes
-  **MAX. POWER**
11,7 hp
-  **MAX. TILLING WIDTH**
80 cm

GRAPH OF THE SPEEDS IN KM/H WITH 5.0-10 WHEELS

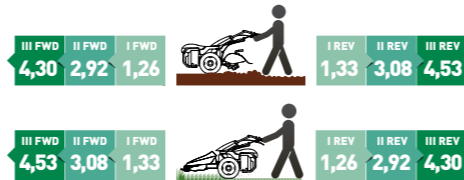

Engine	Fuel	Starter	Power kW/hp
HONDA GX390	Gasoline	Recoil or Electric	8,7 / 11,7
YANMAR L100V	Diesel	Recoil or Electric	6,8 / 9,1
KOHLER KD440	Diesel (with air filter in oil bath)	Electric	8 / 10,5



TWO-WHEEL TRACTORS

360 PowerSafe®

REVERSIBLE TWO-WHEEL TRACTOR WITH MECHANICAL TRANSMISSION AND POWERSAFE® HYDRAULIC CLUTCH.

360 PowerSafe® is a super-professional two-wheel tractor, designed for full-time farmers and garden caretakers.

It's ideal for agricultural work of ploughing and tilling the soil, inter-row mowing of vineyards and orchards, care of gardens in large areas and on particularly rough land.

The cascade reduction units of gears on the two wheels, the reinforced PTO, the differential with lock and independent brakes make 360 PowerSafe® a real 2-wheel tractor.

In addition, the standard quick hitch makes it possible to replace the attachments without using spanners.

-  **NO. OF SPEEDS**
3 + 3
-  **DIFFERENTIAL**
Yes
-  **MAX. POWER**
11,7 hp
-  **MAX. TILLING WIDTH**
85 cm

GRAPH OF THE SPEEDS IN KM/H WITH 6.5/80-12 WHEELS

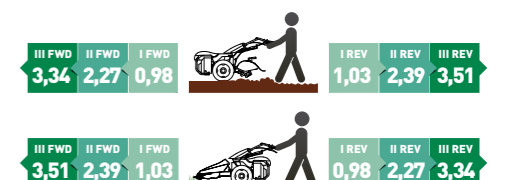

Engine	Fuel	Starter	Power kW/hp
HONDA GX390	Gasoline	Recoil or Electric	8,7 / 11,7
KOHLER KD440	Diesel (with air filter in oil bath)	Recoil or Electric	8 / 10,5



380^{HY}

STARGATE

REVERSIBLE TWO-WHEEL TRACTOR WITH HYDROSTATIC TRANSMISSION (CVT) AND POWERSAFE® HYDRAULIC CLUTCH.

With the 380 HY StarGate model, the new era of the FERRARI multifunctional two-wheel tractors begins.

The new hydrostatic transmission opens up the **approach to the machine with a continuously variable gearbox for an even wider pool of users**, both for amateur use and for professional agricultural use.

The driving position, completely redesigned, **makes using the two-wheel tractor, both with rear and front attachments, even easier, more intuitive and comfortable.**

The engine cover fitted as standard enhances the modern design of the two-wheel tractor.



NO. OF SPEEDS

One-speed range



DIFFERENTIAL

Yes



MAX. POWER

11,7 hp



MAX. TILLING WIDTH

80 cm

Engine	Fuel	Starter	Power kW/hp
HONDA GX390	Gasoline	Recoil or Electric	8,7 / 11,7
YANMAR L100V	Diesel	Recoil or Electric	6,8 / 9,1

GRAPH OF THE SPEEDS IN KM/H WITH 5.0-10 WHEELS

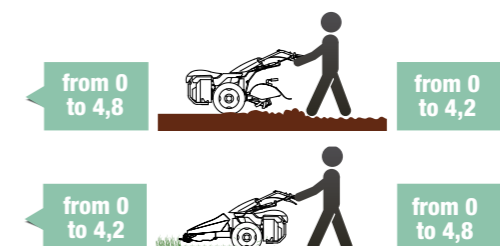

THE ADVANTAGES OF HYDROSTATIC TRANSMISSION

The Continuously Variable Transmission, unlike the mechanical transmission, allows the direction of travel to be reversed and the forward speed to be precisely adjusted to cope with sudden changes in work conditions, without having to stop and without having to operate the clutch, gearbox or inverter lever.

Using only the EasyGrip lever on the handlebar, the operator can increase or decrease the speed of the two-wheel tractor depending on ground conditions, grass density or snow compactness, or quickly reverse direction to manoeuvre around trees or obstacles.

Speed variation and reversing also occur independently of the PTO and engine speed, which means that the implement is always working at maximum speed.

THE BENEFITS OF THE STARGATE SERIES



OPERATING COMFORT

- Handlebars, adjustable and reversible, mounted on newly developed silent-blocks for increased vibration absorption.
- Synthetic levers similar to those of motorbikes, which are even more comfortable to operate⁽¹⁾.
- Soft grips, non-slip high-grip, indispensable for operations on difficult terrain.
- EasyGrip lever control⁽²⁾, practical and intuitive, for precise speed adjustments and quick changes in direction.



HIGH PERFORMANCE

- Continuously variable forward speed in both directions and wheel drive independent of PTO and engine speed.
- Power take-off mechanically connected to the engine to minimise energy dissipation.
- Drive torque always available for work.
- Independent drum brakes on both wheels, with cast-iron shoe as on the more professional models, very useful when using a heavy mower, for example.



SAFETY

- Lever parking brake acting on both wheels.
- Monolithic transmission made of light alloy⁽³⁾ to reduce weight and make the machine compact and easily manoeuvrable on any terrain.
- Safety devices fully compliant with stringent EU regulations.



RELIABILITY

- Active and passive oil cooling system, inside the gearbox and via airflow with dedicated fan⁽⁴⁾, without the need for bulky external cooling coils.
- Patented PowerSafe[®] clutch with multiple steel discs in an oil bath for strength, safety and high performance at all temperatures and conditions of use.



SIMPLIFIED MAINTENANCE

- Entire hydrostatic unit easily accessible for inspection and maintenance.
- Hydrostatic oil filter shared with the clutch circuit.
- Thanks to the complete redesign of the gearbox, the number of components and gears has been reduced, resulting in a lower noise level.

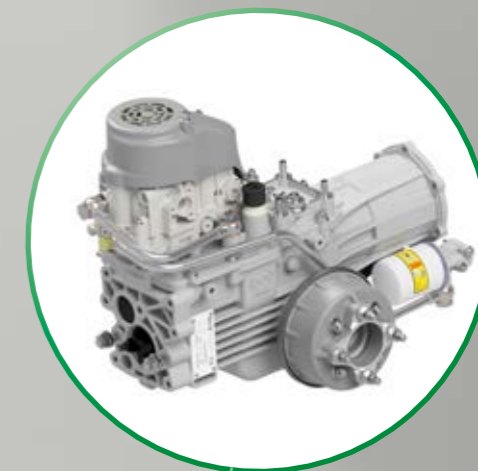

ATTACHMENTS

FERRARI TWO-WHEEL TRACTORS CAN BE USED FOR DIFFERENT WORKS, AS WELL AS FOR CLASSIC TILLING.

THE REVERSIBILITY OF THE HANDLEBARS, COMBINED WITH THE CORRECT RATIO BETWEEN THE FORWARD SPEEDS AND THE INDEPENDENT POWER TAKE-OFF SPEED, ENABLES ALL THE MODELS TO BE USED IN AN EXTREMELY PROFESSIONAL WAY WITH BOTH FRONT AND REAR ATTACHMENTS.

THE WIDE RANGE OF GENUINE ATTACHMENTS MAKES FERRARI TWO-WHEEL TRACTORS INDISPENSABLE TOOLS FOR ALL SEASONS.



ROTARY HOE



USE

Attachment for tilling the soil in preparation for seeding, for burying vegetable residues, eliminating weeds or for weeding between rows in vegetable crops and floriculture.

TECHNICAL FEATURES

Minimum power required*: 3,5 kW (46 cm) - 4,5 kW (52 cm) - 5,5 kW (66 cm) - 7,5 kW (80 cm) - 8 kW (85 cm).

Transmission with gears in oil bath.

Adjustable working depth (not available for 46-cm model).

The tilling width can be adjusted by changing the numbers of knives and the width of the cover (not available for 46-cm model).

Work safety guard for operator safety.

Optional: travel wheel, Precision Depth Roller, ridger behind rotary hoe.

* data purely approximate and referred to standard working conditions

AVAILABLE VERSIONS

Working width: 46 - 52 - 66 - 80 - 85 cm.

PRECISION DEPTH ROLLER



USE

Fitted behind the rotary hoe, the roller allows the tilling depth to be adjusted with extreme precision and the sowing bed to be prepared by levelling the top layer of the soil.

TECHNICAL FEATURES

Rotary hoe work depth adjustment: from 1 cm to the maximum tilling depth.

Steel roller with holes supported by self-lubricating metal bushings.

AVAILABLE VERSIONS

For 66 and 80 cm rotary hoe.

RIDGER



USE

Attachment for creating a furrow in previously tilled soil, opening small drainage ditches and reinforcing row crops.

TECHNICAL FEATURES

Cutting angle of the plough adjustable through the dedicated link.

Cutting depth of the plough adjustable through the dedicated adjustment screw.

Ridge depth adjustable by opening the mouldboards.

Max width of the ridge: 385 mm (410 mm ridger for 360 PowerSafe® two-wheel tractor).

Recommended accessories: 6.5/80-12 wheels and relative weights.

RIDGER BEHIND ROTARY HOE



USE

Mounted behind the rotary hoe, it is the attachment for creating a furrow, opening small drainage ditches or reinforcing row crops.

TECHNICAL FEATURES

Ridge depth adjustable by opening the mouldboards.

Max width of the ridge: 590 mm.

PLOUGH

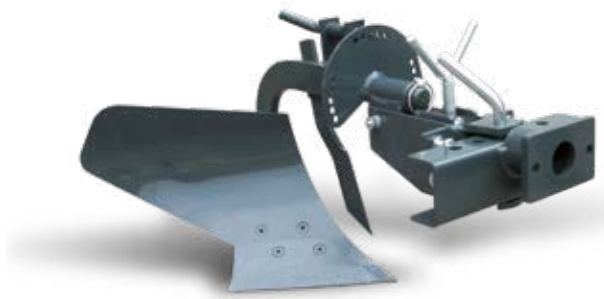

USE

Attachment for tilling and turning over the soil for subsequent processing or directly for sowing. In turning the soil, weeds and previous crops are buried, speeding up their decomposition.

TECHNICAL FEATURES

Working width: 20 cm.

Cutting depth of the plough: adjustable through the dedicated adjustment screw.

Height of the knife: adjustable.

Working angle: adjustable through the dedicated lever.

Recommended accessories: 6.5/80-12 wheels and relative weights.

SWIVEL PLOUGH

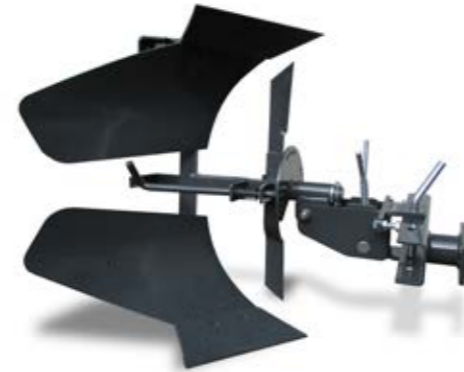

USE

Attachment for tilling and turning over the soil for subsequent processing or directly for sowing. The 180° swivel plough allows overturning the soil always on the same side, both along the forward and return passage.

TECHNICAL FEATURES

Working width: 20 cm.

Two mouldboards rotatable through 180 ° by lever.

Cutting depth of the plough: adjustable through the dedicated adjustment screw.

Height of the knife: adjustable.

Working angle: adjustable through the dedicated lever.

Recommended accessories: 6.5/80-12 wheels and relative weights.

ROTARY PLOUGH GROUNDBLASTER



USE

Attachment for preparing the soil for sowing by integrating ploughing and tilling in a single step, for eliminating weeds, for the tillage of small areas to be cultivated, for creation of furrows, by performing multiple passes.

TECHNICAL FEATURES

Working width: 25 cm.

Minimum power required*: 6,3 kW.

Transmission with gears in oil bath.

Tubular work safety protection for operator safety.

Working depth: adjustable from the rear support wheel.

Side sheet panel supplied for obtaining ridge-free cultivation and to prevent any dropping of the soil onto the nearby crops.

Optional: 5-kg each stackable ballasts.

* data purely approximate and referred to standard working conditions

GROUNDBLASTER SWIVEL ROTARY PLOUGH



USE

Attachment for preparing the soil for sowing by integrating ploughing and tilling in a single step, to turn up new pieces of land for farming. The 180° swivel rotary plough allows overturning the soil always on the same side, both along the forward and return passage.

TECHNICAL FEATURES

Working width: 25 cm.

Minimum power required*: 6,3 kW.

Two ploughshares that rotate with a lever.

Transmission with gears in oil bath.

Tubular work safety protection for operator safety.

Adjustable working depth with the rear supporting wheel.

* data purely approximate and referred to standard working conditions

RIDGER RIDGE 2



USE

Specific front attachment for ridging by removing the earth from the inter-row and placing it at the bottom of the plant or clearing weeds from the furrow.

TECHNICAL FEATURES

Plant inter-row spacing: 90 cm (standard) - 130 cm (with extensions).

Minimum power required*: 5,5 kW.

Transmission with gears in oil bath.

Working depth: adjustable from the little front wheel.

Working width: adjustable from the upper wings.

Optional: pair of extensions, 30-kg ballast.

* data purely approximate and referred to standard working conditions

AVAILABLE VERSIONS

Width of the worked field: 48 - 60 cm.

MULCHING MACHINE PM-F 100



USE

Laying of mulch sheets on the previously tilled and perfectly levelled ground.

TECHNICAL FEATURES

Fixed chassis.

Sheet width: 600 to 1000 mm.

Wheels, front and rear ploughshares adjustable for optimal implement fielding.

Optional: hose reel kit.

Recommended accessories: wheel weights, cage wheels.

MULCHING MACHINE PM-A 100

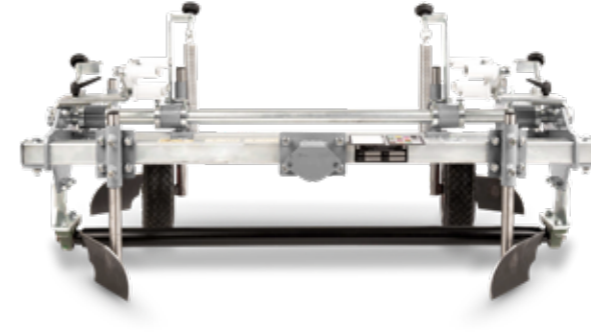

USE

Professional laying of mulch sheets on previously tilled soil. The shock-absorbing chassis allows optimal ground adaptation in the event of depressions.

TECHNICAL FEATURES

Chassis with preload springs connected to the wheels and swing arms of the rear ploughshares.

Sheet width: 800 to 1000 mm.

Wheels, front and rear ploughshares adjustable for optimal implement fielding.

The spring tension is also adjustable via the adjustment knobs.

Optional: hose reel kit.

Recommended accessories: wheel weights, cage wheels.

CUTTER BAR



USE

Attachment for cutting grass and forage without collection on any flat, hilly or mountain ground.

TECHNICAL FEATURES

Cutting widths from 80 to 210 cm.

Slides for cutting height adjustment.

Full thickness screws in the blade base in alloy and tempered steel.

Blade attachment with reinforced tempered steel bridge.

Self-adjusting blade-holders (for Duplex and Dual Laser® Elasto only).

Optional: transmission unit 12-kg ballast.

AVAILABLE VERSIONS

Laser® - with middle cut fingers - Duplex - Dual Laser® with standard or Elasto blade holders.

Transmission in oil bath - Transmission in oil bath with double movement.

SINGLE-BLADE LAWN MOWER



USE

Attachment for cutting grass with grass collector, maintenance of green areas and small public or private gardens.

TECHNICAL FEATURES

- Cutting width: 56 cm.
- Minimum power required*: 3,6 kW.
- Transmission with gears in oil bath.
- Front wheels for maximum manoeuvrability.
- Cutting height: adjustable by lever.
- Automatic blade brake, according to EN 12733 standard.
- Grass catcher: 60 litres capacity.

* data purely approximate and referred to standard working conditions

2-BLADE LAWN MOWER



USE

Attachment for cutting grass with grass collector, professional maintenance of parks, sports fields, public and private gardens.

TECHNICAL FEATURES

- Cutting width: 100 cm.
- Minimum power required*: 7,5 kW.
- Transmission with gears in oil bath.
- Anti-dragging free wheel and automatic blade brake, according to the EN 12733 standard.
- Pivoting blades.
- Adjustable front wheels for the horizontal adjustment of the cutting unit.
- Cutting height: adjustable by lever.
- Grass catcher: 160 litres capacity.

* data purely approximate and referred to standard working conditions

SINGLE-BLADE HEAVY-DUTY MOWER



USE

Attachment for rough cutting with discharge to the ground of grass, shrubs, scrub on uncultivated and undergrowth areas.

TECHNICAL FEATURES

- Cutting width: 80 cm.
- Minimum power required*: 7 kW.
- Automatic blade brake according to the EN 12733 standard and anti-dragging free wheel.
- Transmission with gears in oil bath.
- Swinging axle.
- Front pivoting wheels and adjustable for the horizontal setting of the cutting unit.
- Cutting height: adjustable through suitable spacers.

* data purely approximate and referred to standard working conditions

HEAVY DUTY MOWER BLADERUNNER



USE

Attachment for the heavy-duty maintenance and clearing from brambles, bushes and underbrush of uncultivated land or also for eliminating pruning residues or for controlling weeds between rows.

TECHNICAL FEATURES

- Single-rotor heavy duty mower with "Y"-shaped mobile blades.
- Minimum power required*: 5 kW (60 cm) - 6 kW (75 cm) - 7,5 kW (90 cm) - 8,5 kW (110 cm).
- Automatic blade brake according to the EN 12733 standard and anti-dragging free wheel.
- Main transmission with gears in oil bath and lateral transmission with belts.
- Mobile front opening with canvas and protection bar.
- Front pivoting wheels. They can be locked for processing on slopes (for 90 and 110 cm models only).
- Cutting height: constantly adjustable by crank.
- Optional: lawn mower blades, rear anti-scalp roller, 14-kg ballast.

* data purely approximate and referred to standard working conditions

AVAILABLE VERSIONS

Cutting width: 60 - 75 - 90 - 110 cm.

HEAVY DUTY MOWER ROLLERBLADE



USE

Attachment for eliminating pruning residues and for controlling weeds between rows, for the heavy-duty maintenance and clearing from brambles, bushes and underbrush of uncultivated land, even in sloping areas.

TECHNICAL FEATURES

- Single-rotor heavy duty mower with "Y"-shaped mobile blades.
- Minimum power required*: 6 kW (75 cm) - 7,5 kW (90 cm).
- Automatic blade brake according to the EN 12733 standard and anti-dragging free wheel.
- Main transmission with gears in oil bath and lateral transmission with belts.
- Front opening protected by mobile steel flaps.
- Standard rear anti-scalp roller.
- Cutting height: constantly adjustable by crank.
- Optional: lawn mower blades.

* data purely approximate and referred to standard working conditions

AVAILABLE VERSIONS

Cutting width: 75 - 90 cm.

SNOW BLADE



USE

Attachment for professional snow removal from any surface, gravel or sand handling.

TECHNICAL FEATURES

- Working width: 100 cm.
- Steel structure.
- Polyurethane blade end.
- Curved shape to facilitate the rolling of the snow.
- Orientated laterally directly from the driver position.
- Adjustable ground clearance.
- Optional: 9-kg ballasts, soft blade kit.

DOZER BLADE



USE

Attachment for moving and levelling gravel, sand or soil and for removing snow from coarse surfaces.

TECHNICAL FEATURES

- Working width: 92 cm.
- Steel structure.
- Laterally oriented.
- Used both for pushing and leveling.

TURBINE SNOW THROWER



USE

Attachment for removing snow from avenues, pavements and parking lots quickly and effortlessly by collecting and throwing snow.

TECHNICAL FEATURES

- Minimum power required*: 5 kW (60 cm) - 6 kW (75 cm).
- Transmission with gears in oil bath and cast iron housing.
- Duct made of stainless steel and pivoting by 180° directly from the driving position.
- Adjustable skids to set the ground clearance.
- Safety pins to prevent damage to the impellers in case of impact.
- Optional: 5 kg balancing weight.

* data purely approximate and referred to standard working conditions

AVAILABLE VERSIONS

Working width: 60 - 70 cm.

SWEEPER



USE

Attachment for superficial clearing of snow or cleaning driveways, pavements, parking lots and barns.

TECHNICAL FEATURES

Minimum power required*: 6,3 kW.

Transmission with gears in oil bath and cast iron housing.

Brush: nylon or nylon and steel (for 100 and 120 cm models only).

Rear wheels for better manoeuvrability.

Sideways adjustable directly from the driving position.

Adjustable cleaning height.

* data purely approximate and referred to standard working conditions

AVAILABLE VERSIONS

Working width: 80 - 100 - 120 cm.

PNEUMATIC WHEELS



USE

Pneumatic wheels with different dimensions and profiles for various types of applications in agriculture, greens maintenance or haymaking.

TECHNICAL FEATURES

Tractor: agricultural use. The thread lug design also allows a good grip on hard and soft terrain.

Lug Tyre: agricultural use. The thread lug design always ensures good grip but with less soil compaction.

Terra Tyre: used for greens maintenance and haymaking. The widened profile allows greater flotation and minimum soil compaction.

Garden: used for greens maintenance on finer surfaces. The low compaction profile protects the turf.

METAL WHEELS



USE

Iron wheels fitted instead of pneumatic wheels for various types of use in the agricultural field.

TECHNICAL FEATURES

Steel cage: agricultural use on very hard soils. The crosspieces penetrate into the ground preventing the wheels from slipping. Steel cage wheels can also be used on loose and soft soils where the pneumatic wheels could sink.

Twinning rings: coupled to the cage wheels, they double the support surface and anchorage on the ground.

WHEEL WEIGHTS



USE

Secured to the wheel hubs, they are used to weigh down the two-wheel tractor and therefore provide greater traction, enhancing performance and safety levels.

AVAILABLE VERSIONS

Weight (each): 11 - 15 - 34 kg

WHEEL SPACERS



USE

The wheel spacers are designed to widen the machine's track by 6 cm on either side, thereby improving its stability on cross slopes or on rough terrain.

ROTARY HOE TRAVEL WHEEL



USE

Mounted behind any FERRARI rotary hoe, it makes transporting the two-wheel tractor to the field easier and less tiring.

PTO EXTENSION



USE

A useful accessory to balance the weight between the machine and the attachment. One or more 8 cm extensions can be fitted to distance the attachment from the two-wheel tractor and increase its ground weight or to prevent the attachment from interfering with the wheels.

TRACTOR PTO COUPLER



USE

Applied to the machine's standard PTO, it carries a splined shaft on the outside like the tractor PTO, allowing the connection of cardan joints, pulleys, spray pumps and various implements.

TWIN WHEEL KIT



USE

It allows two wheels to be twinned, increasing traction on the ground or improving the stability of the two-wheel tractor on cross slopes.

QUICK HITCH



USE

Comprising a tang and a bush, the quick hitch is the ideal accessory to change attachments quickly and easily, without having to use any spanners.

Standard on 360 PowerSafe® two-wheel tractor.

PTO ADAPTERS



USE

They allow the mounting of tools with a Z10 grooved PTO coupling on new machines with a 3-tooth PTO coupling, and vice versa.

ENGINE COVER



USE

FERRARI two-wheel tractors can also have an engine bonnet, which improves the machine appearance.

Available for Honda, Kohler and Yanmar engines.

DIGITAL HOUR COUNTER



USE

It precisely measures the two-wheel tractor's working hours and makes it possible to keep the maintenance schedule under control.

The IP68 waterproof design also lets you use it under the rain.

LUBRICANTS



USE

The original PowerLube lubricants are the only ones that guarantee both the hydraulic and mechanical components of the FERRARI two-wheel tractors function properly and, at the same time, ensuring their perfect efficiency over time.

TECHNICAL FEATURES

High quality synthetic bases and raw materials.

Formulated specifically for FERRARI two-wheel tractors.

AVAILABLE VERSIONS

Mechanical and hydromechanical transmission lubricant.
Hydrostatic transmission and engine lubricant.

FERRARI ORIGINAL SPARE PARTS



USE

Only by using original spare parts will you be sure to maintain the performance of your FERRARI two-wheel tractor.

All FERRARI two-wheel tractors offer high performance every day in total safety and you will surely want them to continue working as they did on the first day, providing the same performance and reliability.

That is why you should choose only original FERRARI spare parts made by those who design and build the machines, control the processes and guarantee high quality standards.

TECHNICAL FEATURES

	Engine	Fuel	Starter	Power kW/hp	Transmission	Speeds FWD+REV	Quick reverser	Clutch	Brakes	Differential	PTO	Handlebar	Available wheels	Safety devices	FERRARI attachments which can be mounted
306 SmartSafe®	GENKINS GK210	Gasoline	Recoil	4,4 / 5,9	Mechanical, with gears and worm screw in oil bath	1 + 1	No	SmartSafe®, mechanically operated with multiple discs in oil bath	No	No	Independent from gearbox. At 990 rpm (with engine at 3600 rpm) with engagement in oil bath	Mounted on silent-blocks, adjustable in height, sideways and reversible	3.50-8 Steel cage wheels Ø43 cm	In compliance with the EN 709/A4 standard	Rotary hoe, cutter bar, lawn mower, snow blade, sweeper
328 PowerSafe®	HONDA GP160	Gasoline	Recoil	3,6 / 4,8	Mechanical, with gears and worm screw in oil bath	3 + 3	Yes, with mechanical control on the handlebar	PowerSafe®, hydraulically operated with multiple discs in oil bath	Parking brake	No	Independent from gearbox. At 990 rpm (with engine at 3600 rpm) with engagement in oil bath	Mounted on silent-blocks, adjustable in height, sideways and reversible	4.00-8 4.0-10 5.0-10 5.0-12 6.5/80-12 Steel cage wheels Ø43 cm	In compliance with the EN 709/A4 standard	Rotary hoe, PDR, ridger, plough, cutter bar, lawn mower, BladeRunner, RollerBlade, snow blade and turbine snow thrower, sweeper
	HONDA GX200	Gasoline	Recoil	4,1 / 5,5											
	HONDA GX270	Gasoline	Recoil	6,3 / 8,6											
338 PowerSafe®	HONDA GX270	Gasoline	Recoil or electric	6,3 / 8,6	Mechanical, with gears and worm screw in oil bath	3 + 3	Yes, with mechanical control on the handlebar	PowerSafe®, hydraulically operated with multiple discs in oil bath	Parking brake on the two wheels	With lock	Independent from gearbox. At 990 rpm (with engine at 3600 rpm) with engagement in oil bath	Mounted on silent-blocks, adjustable in height, sideways and reversible	5.0-10 5.0-12 6.5/80-12 Steel cage wheels Ø 49 cm	In compliance with the EN 709/A4 standard	Rotary hoe, PDR, ridger, plough, GroundBlaster, Ridge 2, mulching machine, cutter bar, lawn mower, heavy-duty mower, BladeRunner, RollerBlade, snow blade and turbine snow thrower, sweeper
	HONDA GX340	Gasoline	Recoil	8 / 10,7											
	KOHLER KD350	Diesel	Recoil or electric	5,5 / 7,5											
340 PowerSafe®	HONDA GX390	Gasoline	Recoil or electric	8,7 / 11,7	Mechanical, with gears and worm screw in oil bath	3 + 3	Yes, with mechanical control on the handlebar	PowerSafe®, hydraulically operated with multiple discs in oil bath	Independent working brakes on the two wheels and parking brake	With lock	Independent from gearbox. At 990 rpm (with engine at 3600 rpm) with engagement in oil bath	Mounted on silent-blocks, adjustable in height, sideways and reversible	5.0-10 5.0-12 6.5/80-12 6.5/80-15 Steel cage wheels Ø 49 cm	In compliance with the EN 709/A4 standard	Rotary hoe, PDR, ridger, plough, GroundBlaster, Ridge 2, mulching machine, cutter bar, lawn mower, heavy-duty mower, BladeRunner, RollerBlade, snow blade and turbine snow thrower, sweeper
	YANMAR L100V	Diesel	Recoil or electric	6,8 / 9,1											
	KOHLER KD440	Diesel (with air filter in oil bath)	Electric	8 / 10,5											
360 PowerSafe®	HONDA GX390	Gasoline	Recoil or electric	8,7 / 11,7	Mechanical, with gears and worm screw in oil bath	3 + 3	Yes, with mechanical control on the handlebar	PowerSafe®, hydraulically operated with multiple discs in oil bath	Independent working brakes on the two wheels and parking brake	With lock	Independent from gearbox. At 990 rpm (with engine at 3600 rpm) with engagement in oil bath	Mounted on silent-blocks, adjustable in height, sideways and reversible	6.5/80-12 6.5/80-15 Steel cage wheels Ø 58 cm	In compliance with the EN 709/A4 standard	Rotary hoe, ridger, plough, mulching machine, lawn mower, heavy-duty mower, BladeRunner, RollerBlade, sweeper
	KOHLER KD440	Diesel (with air filter in oil bath)	Recoil or electric	8 / 10,5											
380HY STARGATE	HONDA GX390	Gasoline	Recoil or electric	8,7 / 11,7	Hydrostatic StarGate, with final worm screw reduction in oil bath	One-speed range in both FWD and REV	Yes, by hydrostatic unit with EasyGrip lever on the handlebar	PowerSafe®, hydraulically operated with multiple discs in oil bath	Independent working brakes on the two wheels and parking brake	With lock	Independent from gearbox. At 990 rpm (with engine at 3600 rpm) with engagement in oil bath	Mounted on silent-blocks, adjustable in height, sideways and reversible	5.0-10 5.0-12 6.5/80-12 6.5/80-15 Steel cage wheels Ø 49 cm	In compliance with the EN 709/A4 standard	Rotary hoe, PDR, ridger, plough, GroundBlaster, Ridge 2, mulching machine, cutter bar, lawn mower, heavy-duty mower, BladeRunner, RollerBlade, snow blade and turbine snow thrower, sweeper
	YANMAR L100V	Diesel	Recoil or electric	6,8 / 9,1											

For more info, size and weights go to www.ferrariagri.com

THE SERVICES



SPARE PARTS

A complete range of original spare parts, guaranteed directly by the manufacturer.



ASSISTANCE

A team of specialists, well prepared and available to assure an efficient and resolving service.



LUBRICANTS

We recommend to use the original PowerLube lubricants.



FINANCIAL SERVICES

Financial solutions to meet the credit requirements.

The information indicated in this folder is not binding. The models described may be modified, without notice, by the Manufacturer. The drawings and photos may refer to equipment that is either optional or intended for other countries. Please apply to our Sales Network for any further information. FERRARI guarantees the safety requirements according to the regulations only if the machine is used according to the instructions supplied and coupled with the FERRARI manufactured attachments. FERRARI declines any responsibility if any other attachment is used or in case of alteration and/or improper use.

MZ

09/24

90100701GB



MADE IN ITALY